

Instructions for assembling furniture Instrukcja montażu mebli Collection Kolekcja mebli

«MODERN»

Bed 90-2
Łóżko 90-2

AH-081.07.00.00

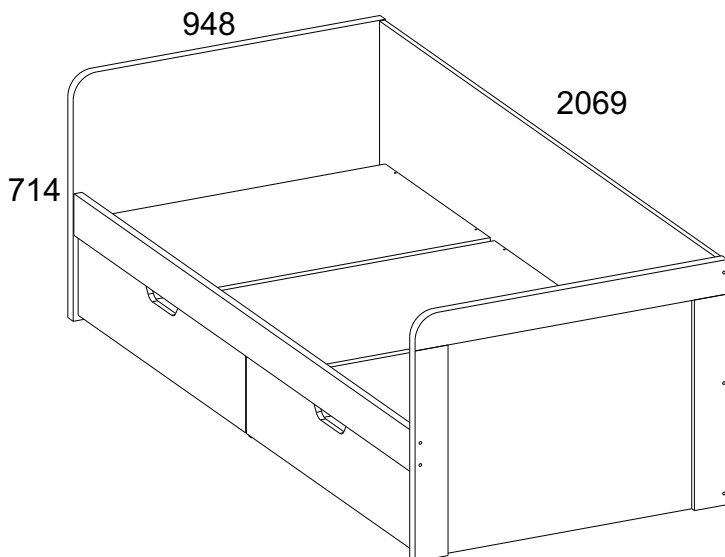

Dodatkowe elementy do zakupu
Additional element for buy

Strona ochronna
Protective side

AH-081.68.00.00

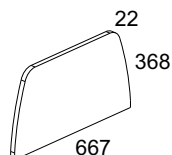

Production date
Data produkcji

Stamp of Quality Department
Pieczęć Działu Jakości

PL**Przy eksploatacji mebli zabrania się:**

- ustawiać meble w pobliżu grzewczych przyrządów i obok wilgotnych ścian, a także w pomieszczeniach ze względną wilgotnością więcej niż 70%;
- temperatura nagrzewania elementów mebli nie może przekraczać +40°C;
- w trakcie montażu i eksploatacji mebli stawać nogami na poziome panele i witryny;
- stosować chemiczne środki czyszczące do sprzątanía mebli;
- nie należy narażać na kontakt z wodą.

Zapach.

Nowe meble mogą wydzielać zapach materiałów, z których są wykonane. Zapach może utrzymywać się do trzech tygodni od momentu montażu. Aby zmniejszyć intensywność zapachu, zaleca się:

- w przypadku mebli tapicerowanych - odkurzyć produkt i przewietrzyć pomieszczenie.

Powtarzaj 3-4 razy dziennie.

- dla mebli szafkowych - przetrzyj ściereczką zwilżoną łagodnym detergentem, przetrzyj czystą, suchą ściereczką i przewietrz pomieszczenie, uprzednio otwierając wszystkie drzwi i szuflady produktu.

Powtarzaj 3-4 razy dziennie.

Ważne! Proszę zachować instrukcję w razie ponownego montażu mebli lub reklamacji. Podczas składania reklamacji prosimy o korzystanie z oznaczeń z instrukcji.

DE**Bei der Benutzung der Möbel ist es verboten:**

- Möbel in der Nähe von Heizgeräten und neben feuchten Wänden sowie in Räumen mit einer relativen Luftfeuchtigkeit von mehr als 70 % aufstellen;
- Heiztemperatur von Möbelementen darf + 40 ° C nicht überschreiten;
- Stellen Sie sich während der Montage und Verwendung von Möbeln mit den Füßen auf die horizontalen Paneele und Fenster;
- zur Reinigung von Möbeln chemische Reinigungsmittel verwenden;
- sollte keinem Wasser ausgesetzt werden.

Geruch.

Neue Möbel können nach den Materialien riechen, aus denen sie bestehen. Der Duft kann bis zu drei Wochen nach der Installation anhalten. Um die Intensität des Duftes zu verringern, wird empfohlen:

- bei Polstermöbeln das Produkt absaugen und den Raum lüften.

3-4 mal täglich wiederholen.

- für Schrankmöbel - mit einem mit einem milden Reinigungsmittel angefeuchteten Tuch abwischen, mit einem sauberen, trockenen Tuch abwischen und den Raum lüften, indem Sie zuerst alle Türen und Schubladen des Produkts öffnen.

3-4 mal täglich wiederholen.

Wichtig! Bitte bewahren Sie die Anleitung für den Fall eines Möbelumbaus oder einer Reklamation auf. Bitte verwenden Sie bei einer Reklamation die Markierungen im Handbuch.

FR**Lors de l'utilisation du mobilier, il est interdit de :**

- placez les meubles à proximité d'appareils de chauffage et à côté de murs humides, ainsi que dans des pièces dont l'humidité relative est supérieure à 70 % ;
- la température de chauffage des éléments de mobilier ne doit pas dépasser + 40 ° C ;
- lors du montage et de l'utilisation des meubles, placez vos pieds sur les panneaux horizontaux et les fenêtres ;
- utiliser des produits de nettoyage chimiques pour nettoyer les meubles ;
- ne doit pas être exposé à l'eau.

Sentir.

Les nouveaux meubles peuvent dégager une odeur des matériaux dont ils sont faits. L'odeur peut persister jusqu'à trois semaines après l'installation. Pour réduire l'intensité du parfum, il est recommandé de :

- dans le cas de meubles rembourrés - aspirer le produit et aérer la pièce.

Répétez 3-4 fois par jour.

- pour les meubles de rangement - essuyez avec un chiffon imbibé d'un détergent doux, essuyez avec un chiffon propre et sec et aérez la pièce en ouvrant d'abord toutes les portes et tous les tiroirs du produit.

Répétez 3-4 fois par jour.

Important! Veuillez conserver la notice en cas de remontage du meuble ou de réclamation. Lorsque vous soumettez une plainte, veuillez utiliser les marquages dans le manuel.

SPA**Al utilizar los muebles, está prohibido:**

- colocar muebles cerca de aparatos de calefacción y junto a paredes húmedas, así como en habitaciones con una humedad relativa superior al 70%;
- la temperatura de calentamiento de los elementos del mobiliario no debe exceder los + 40 ° C ;
- durante el montaje y uso de los muebles, párese con los pies sobre los paneles horizontales y las ventanas;
- utilizar agentes de limpieza químicos para limpiar los muebles;
- No debe exponerse al agua.

Oler.

Los muebles nuevos pueden desprender el olor de los materiales de los que están hechos. El olor puede persistir hasta tres semanas después de la instalación. Para reducir la intensidad de la fragancia, se recomienda:

- en el caso de muebles tapizados - aspirar el producto y ventilar la estancia.

Repite 3-4 veces al día.

- para muebles de gabinete - limpie con un paño humedecido con un detergente suave, limpie con un paño limpio y seco y ventile la habitación, abriendo primero todas las puertas y cajones del producto.

Repite 3-4 veces al día.

Importante! Conserve las instrucciones en caso de reensamblaje de muebles o reclamaciones. Al enviar una queja, utilice las marcas en el manual.

№	L, mm	B, mm	H, mm	Q	№ pack
1	948	710	32	1	2/3
2	948	710	32	1	2/3
3	708	2005	16	1	3/3
4	120	2005	28	1	3/3
5	900	40	16	4	3/3
9	998	230	16	2	1/1
10	600	180	16	2	3/3
11	600	180	16	2	3/3
12	912	180	16	2	3/3
13	600	100	16	4	1/3
14	900	290	16	1	1/3
17	898	625	16	3	1/3
18	942	605	2,5	2	1/3
20	500	60	16	3	3/3

Dodatkowe elementy do zakupu Strona ochronna
Additional element for buy Protective side

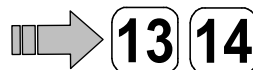



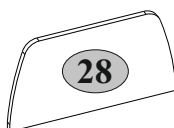

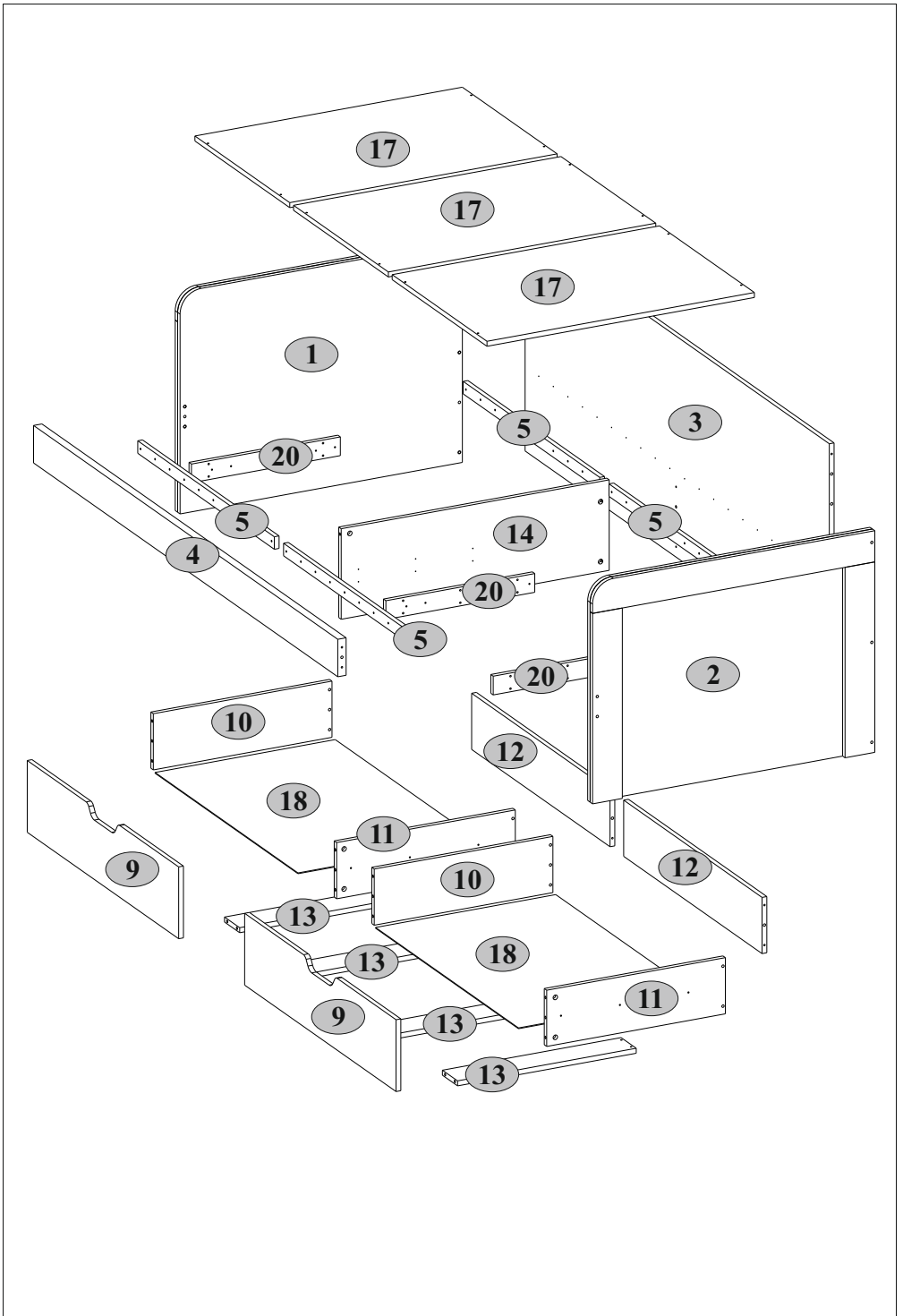





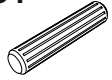

№	L, mm	B, mm	H, mm	Q	№ pack
28	667	368	22	1	1/1

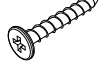
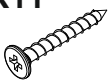





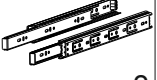

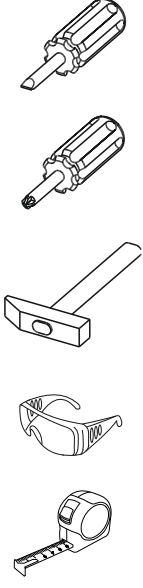
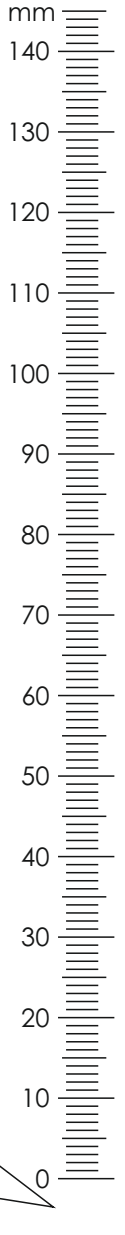
A1  7x34 15	A2  Ø15x12 15	C1  8x35 22	I  S4 1
N1  9	Q  1,5x7 4	R3  3x20 24	R10  4x30 58
R11  4x35 12	R12  4x40 8	R24  7x50 8	R25  7x70 10
R27  5,0x13 28	S5  Ø18 8	S8  Ø14 10	Z14  500 2



Dodatkowe elementy do zakupu
Additional element for buy

Strona ochronna
Protective side

R103  3,5x20 6	U16  2
--	--

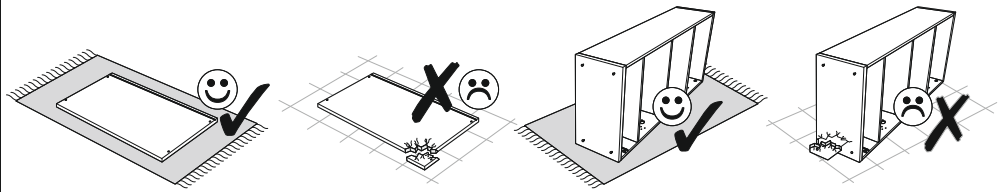
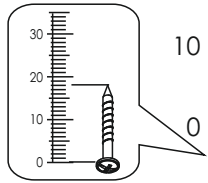
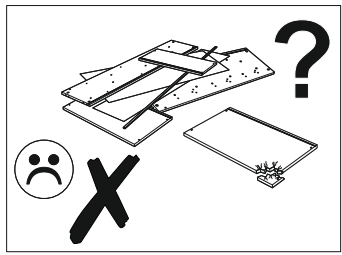

1

A1



7x34

C1

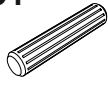

3 8x35

N1



8

R10



3 4x30 40

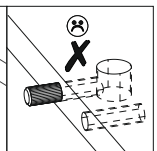
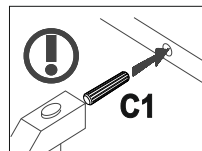
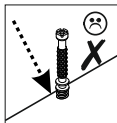
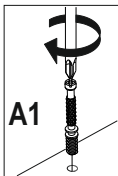
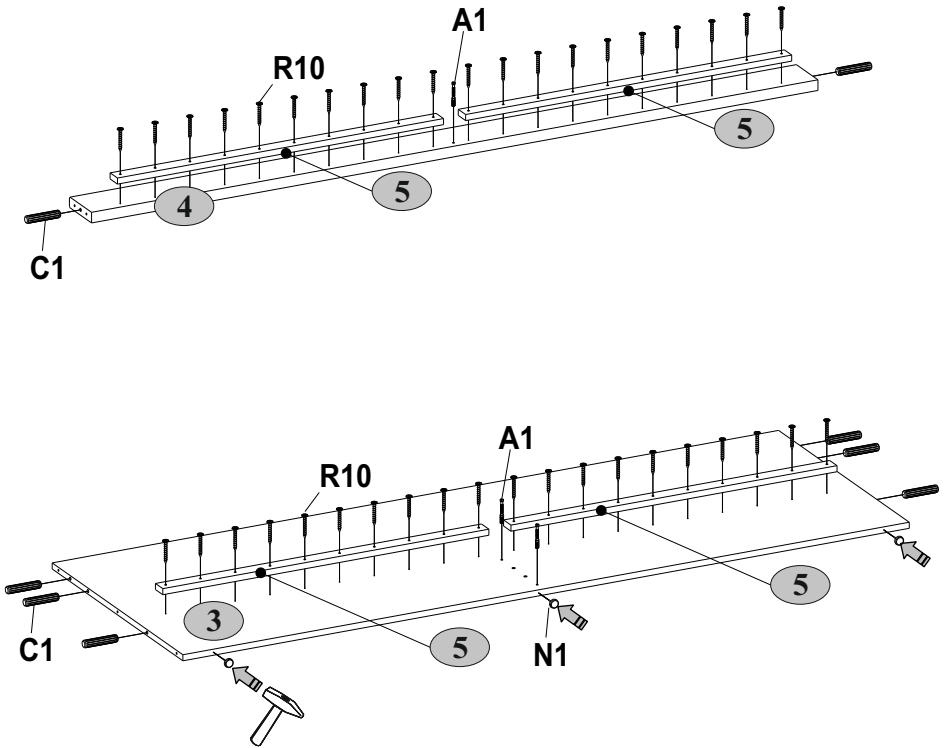

2**A2**

Ø15x12

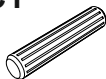
C1

3 8x35

N1

2

R10

6 4x30

R27

18 5,0x13

16

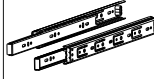
Z14

500

2

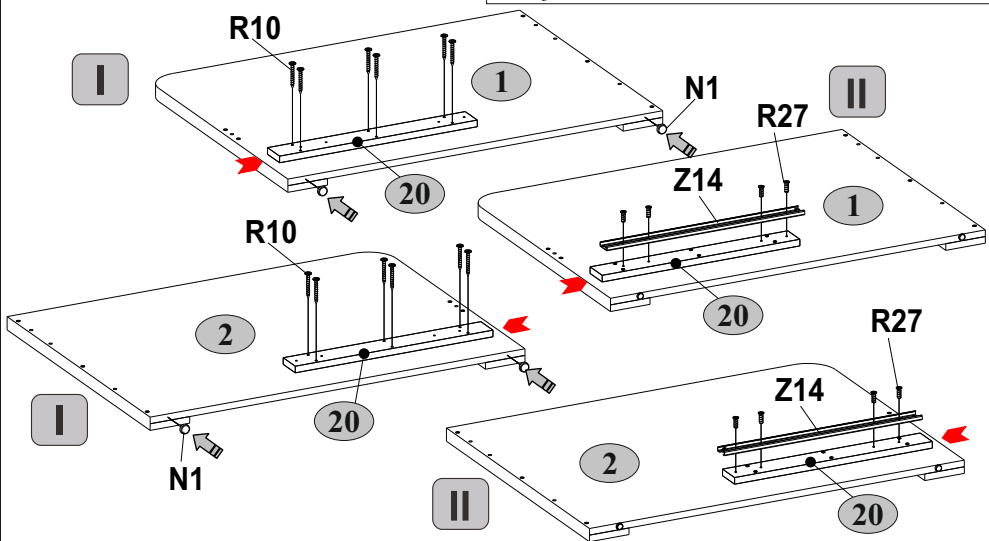
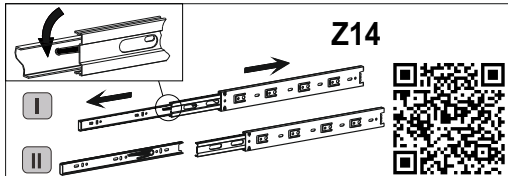
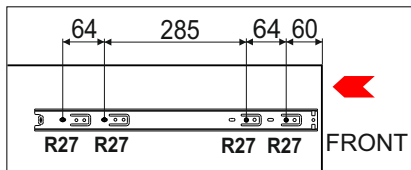
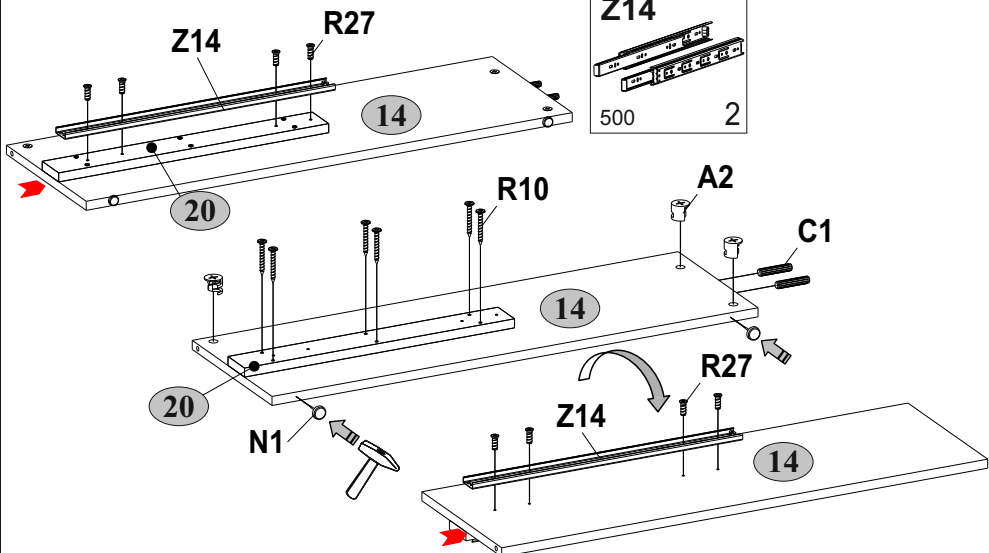

3

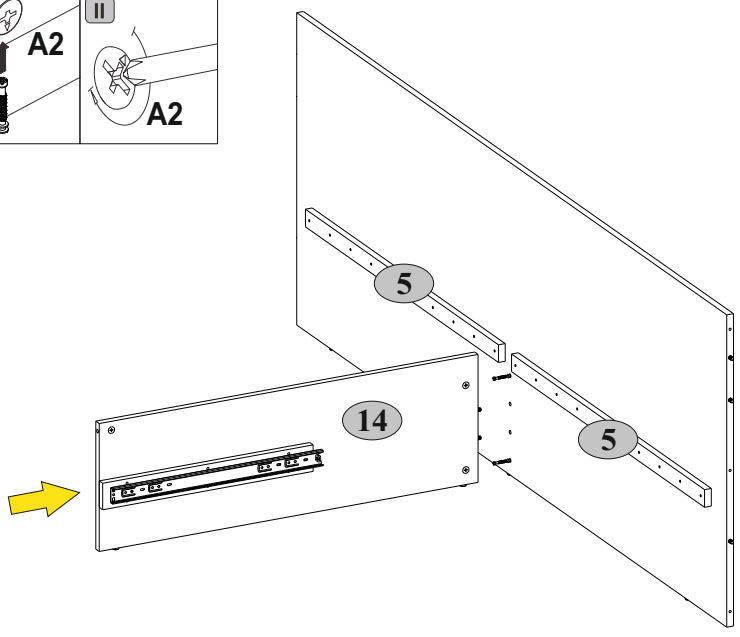
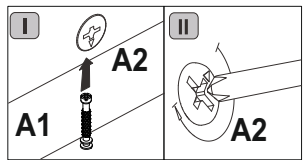

4

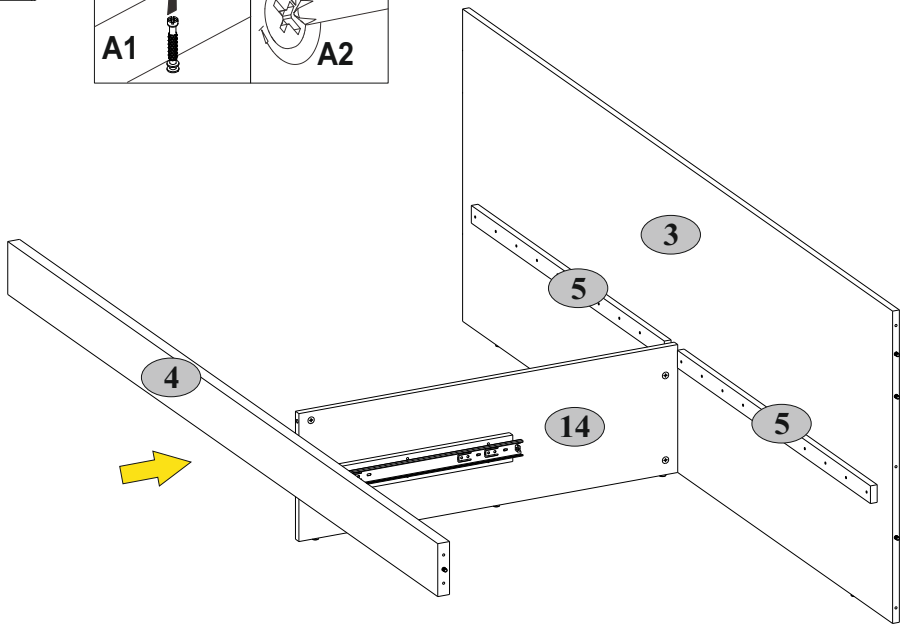
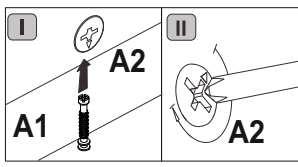

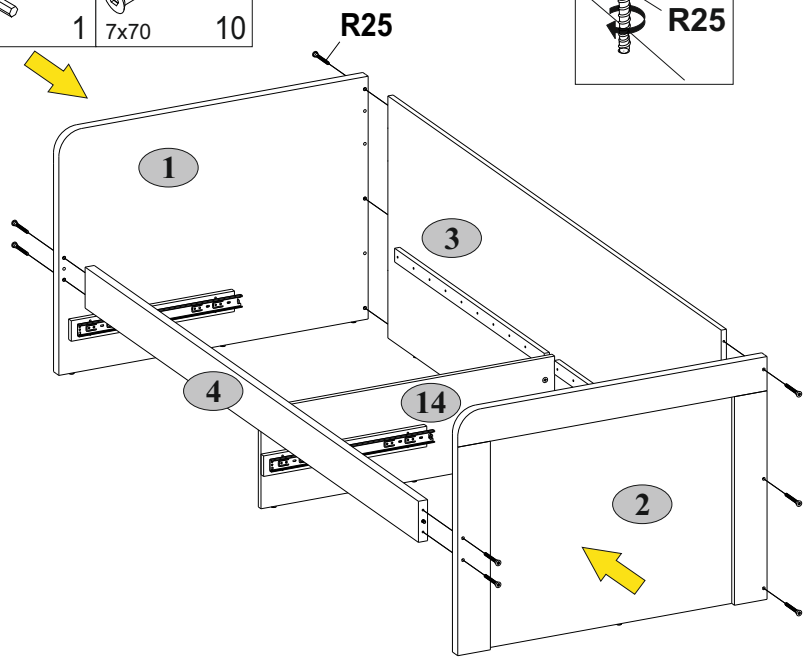
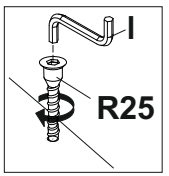
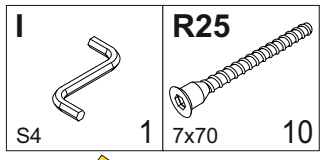

5

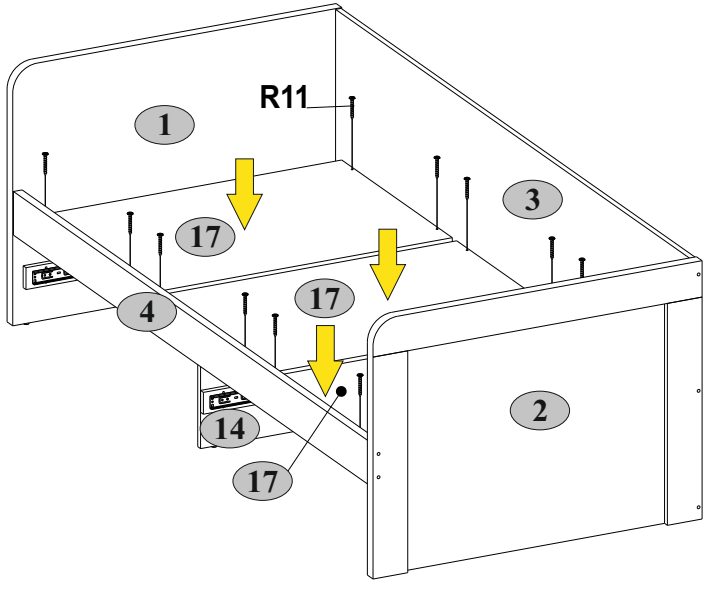
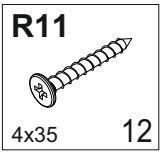

6



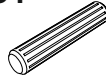

7

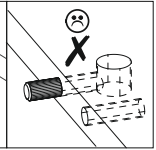
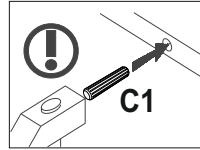
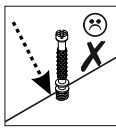
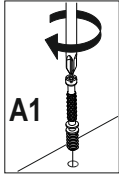
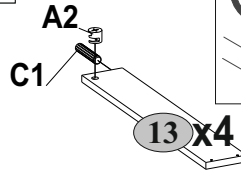
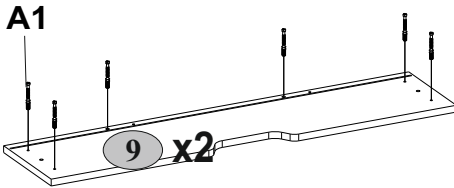
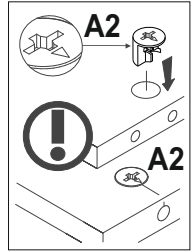
A1 	A2 	C1 
7x34 12	Ø15x12 4	8x35 4

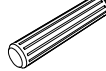
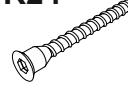

8

x2

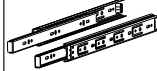
A2 	C1 	R24 	R27 	Z14 
Ø15x12 8	8x35 8	7x50 8	5,0x13 12	500 2

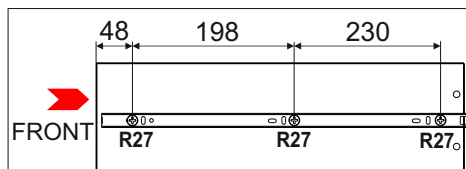
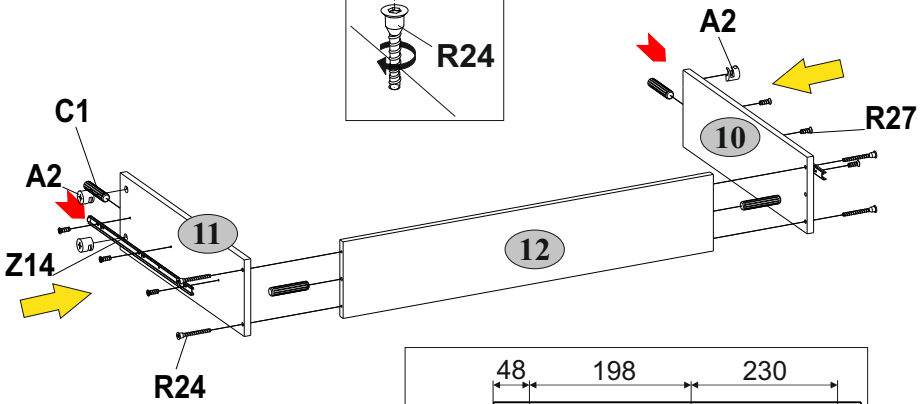
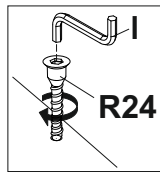

9
x2

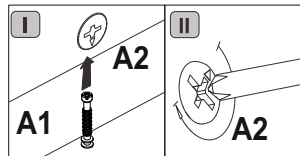
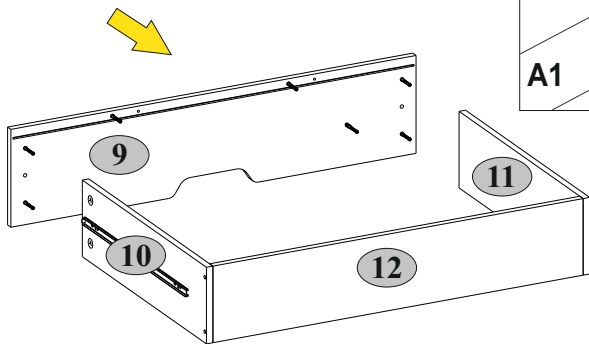

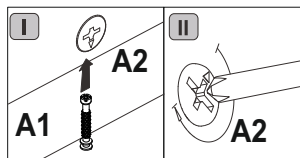
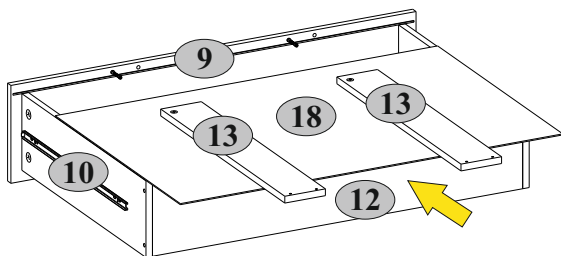

10
x2

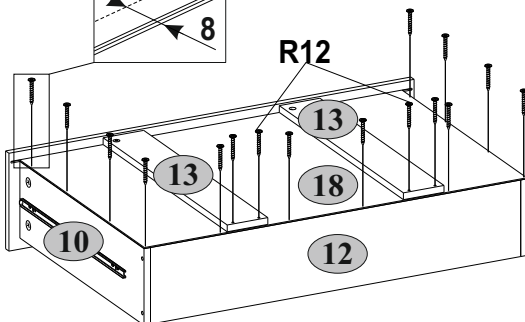
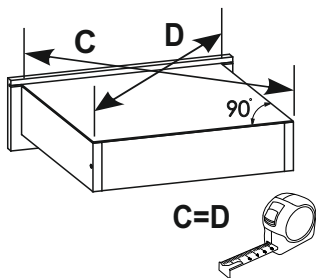
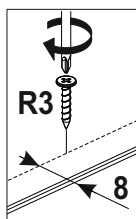
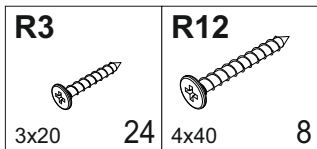
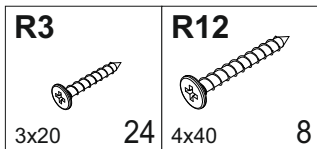

11
x2



12

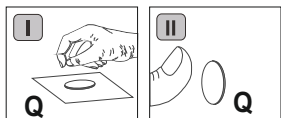
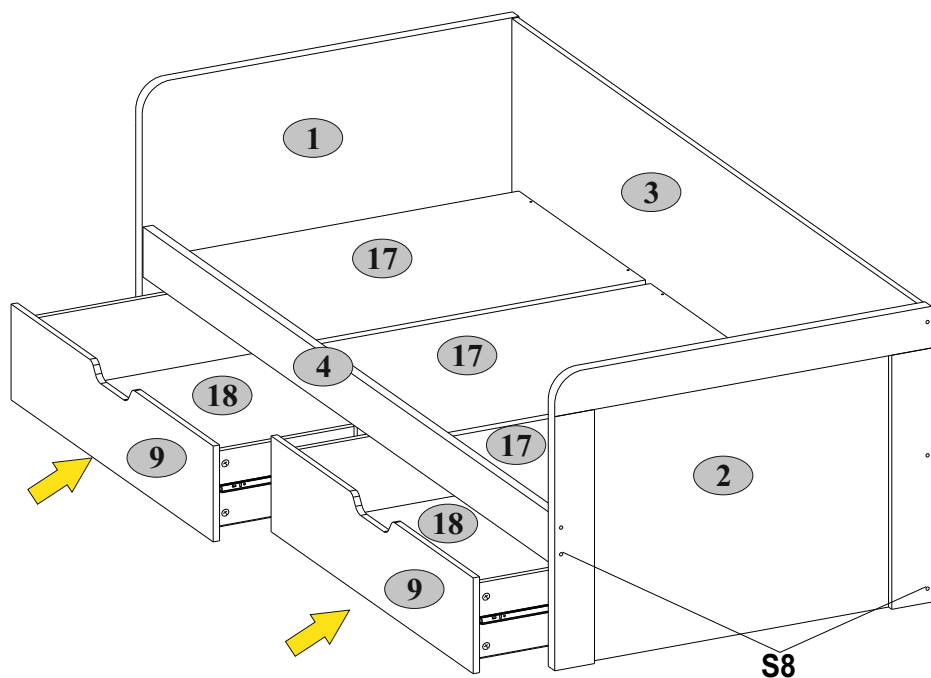
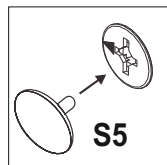
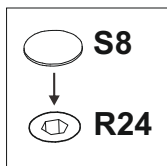

Q  1,5x7	S5  4 Ø18	S8  8 Ø14
--	---	---



18  max. 5 kg

17  max. 90 kg

13

R103  3,5x20 4	U16  2
---	--

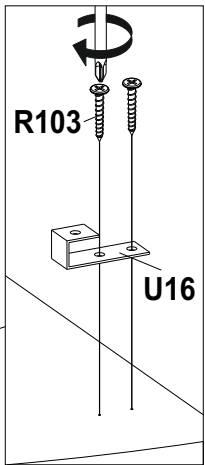
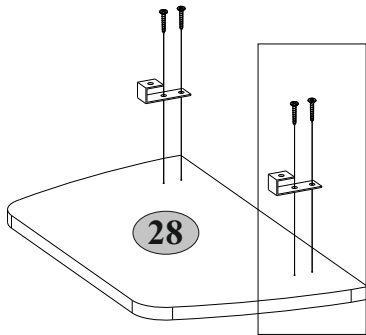

14

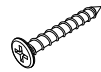
R103  3,5x20 2

